

COMPACT M 12

TWO-WAY PROFESSIONAL SPEAKER

DESCRIPTION

COMPACT M 12 is a multipurpose two-way full-range speaker system, suitable for a wide range of applications. Its balanced sound is a big asset in near-field applications for the best intelligibility. The M 12 features high sensitivity, typical of professional audio cabinets thanks to the use of oversized magnets and a HI-FI sound quality, with smooth and wide frequency response, thanks to the wave-guided compression driver. The SPL level of low-distortion audio the M 12 can provide goes far beyond expectations of such a compact solution. The elegant and compact design with accurate finishing makes M 12 suitable for almost any environment, even with architectural constraints. Optional mounting accessories allow using M 12 on wall or ceiling installations.



FEATURES

- 300 W RMS power handling
- 129 dB max SPL
- 55 ÷ 20000 Hz frequency range
- 90° x 70° constant directivity coverage angle
- 1 x 12" high power woofer
- 1 x 1.4" voice coil compression driver
- High quality plywood cabinet
- Steel front grille with clothing
- Installation points available on rear, top and bottom panels
- 4 pole EUROBLOCK connector (audio input and parallel link output)

TECHNICAL SPECIFICATIONS

Acoustical specifications	Frequency Response (-10dB):	55 Hz ÷ 20000 Hz
	Max SPL @ 1m:	129 dB
	Horizontal coverage angle:	90°
	Vertical coverage angle:	70°
	Directivity index Q:	9
	System Sensitivity:	98 dB
Power section	Nominal Impedance:	8 ohm
	Power Handling:	300 W RMS
	Peak Power Handling:	1200 W PEAK
	Recommended Amplifier:	600 W
	Protections:	Dynamic active mosfet
	Crossover Frequencies:	1800 Hz
Transducers	Compression Driver:	1 x 1.0", 1.4" v.c
	Woofers:	12", 2.5" v.c
Input/Output section	Input connectors:	Euroblock
	Output connectors:	Euroblock
Standard compliance	CE marking:	Yes
Physical specifications	Cabinet/Case Material:	Plywood
	Hardware:	8 x M8, 8 x M10
	Grille:	Steel with clothing
	Color:	Black - RAL 9005, White - RAL 9003
Size	Height:	620 mm / 24.41 inches
	Width:	362 mm / 14.25 inches
	Depth:	404 mm / 15.91 inches
	Weight:	22 kg / 48.5 lbs
Shipping informations	Package Height:	655 mm / 25.79 inches
	Package Width:	442 mm / 17.4 inches
	Package Depth:	400 mm / 15.75 inches
	Package Weight:	25.5 kg / 56.22 lbs

PART NUMBER

- **13000724**
COMPACT M 12 W
White - RAL 9003
EAN 8024530019365

- **13000596**
COMPACT M 12
Black - RAL 9005
EAN 8024530017811

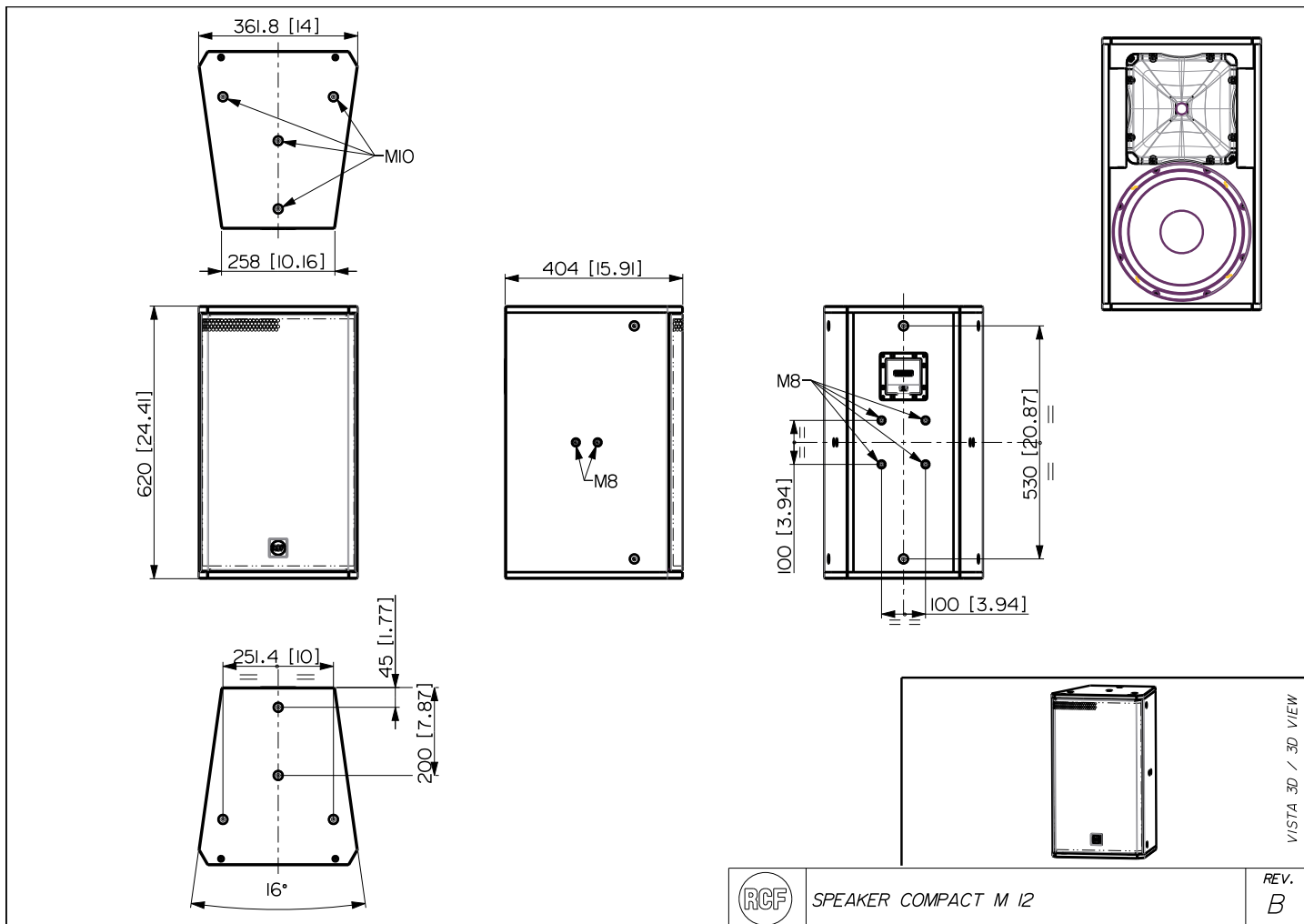

SPEAKER COMPACT M 12

REV.
B

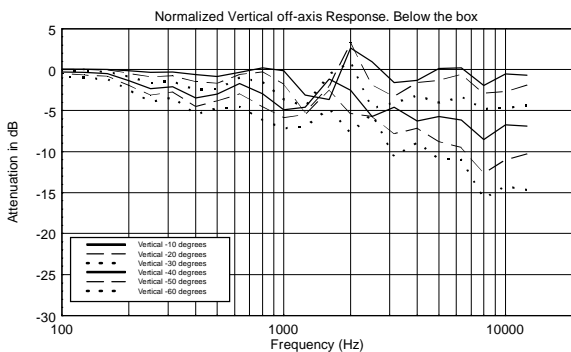
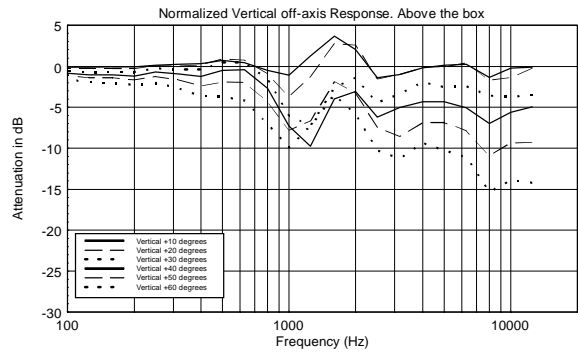
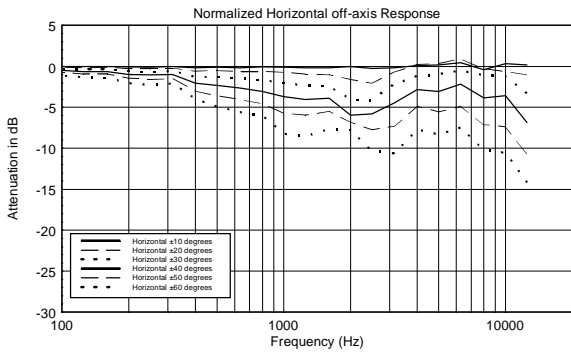
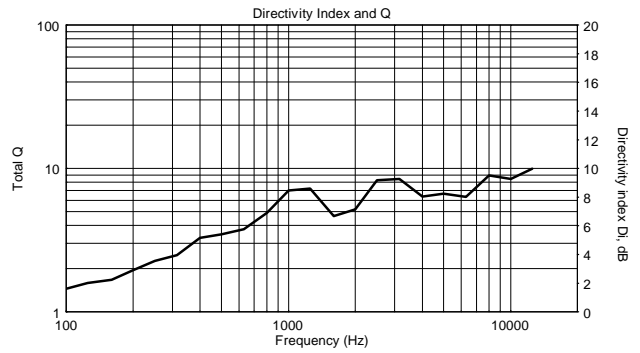
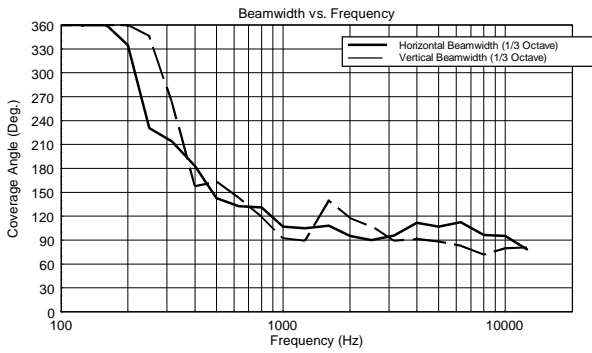
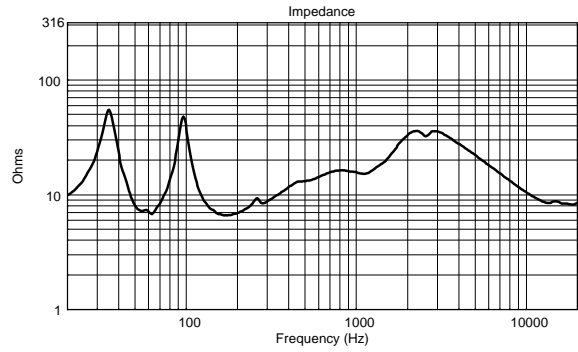
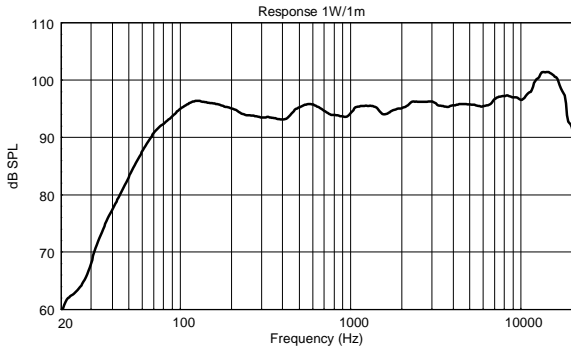

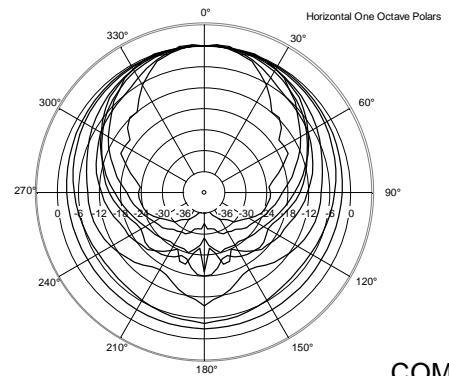
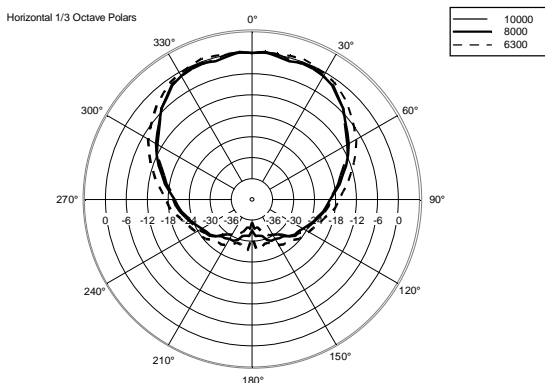
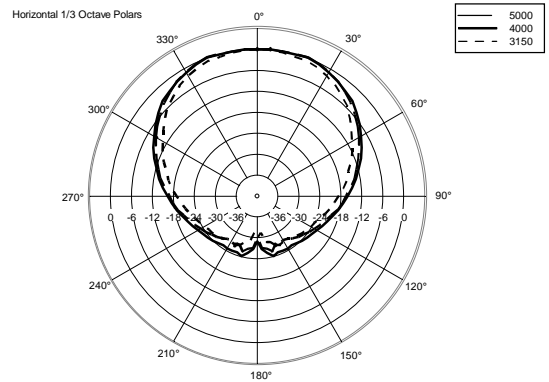
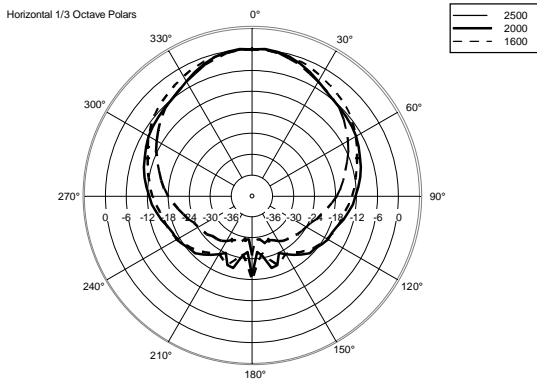
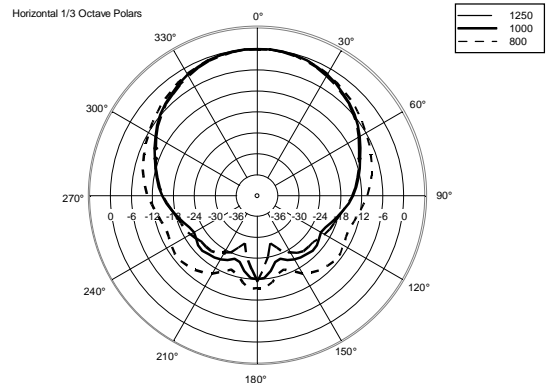
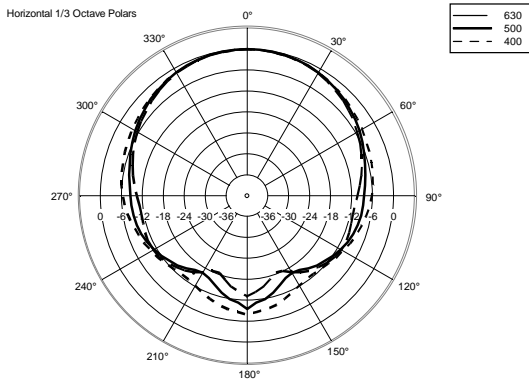
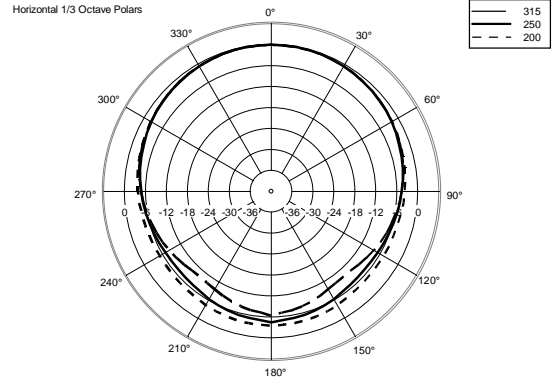
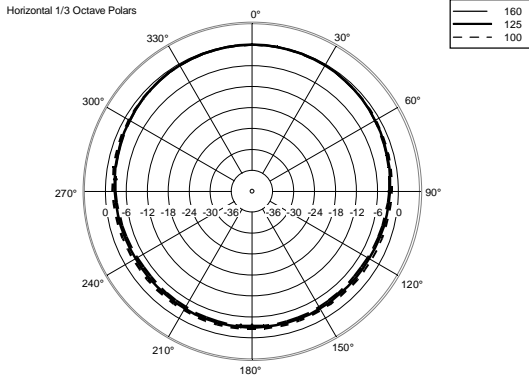

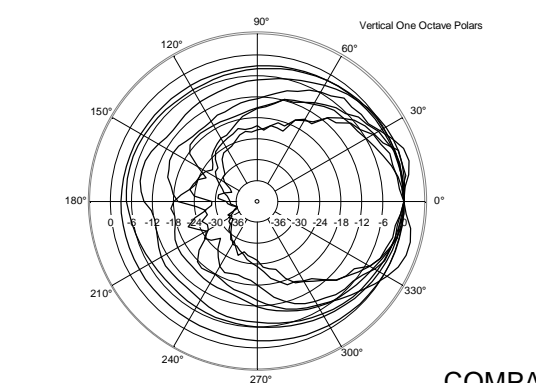
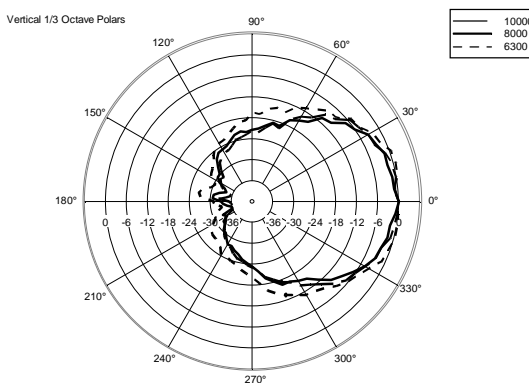
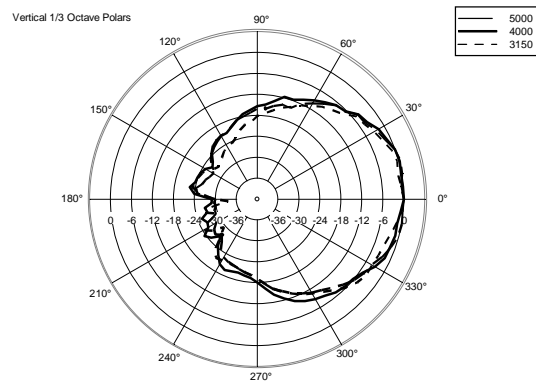
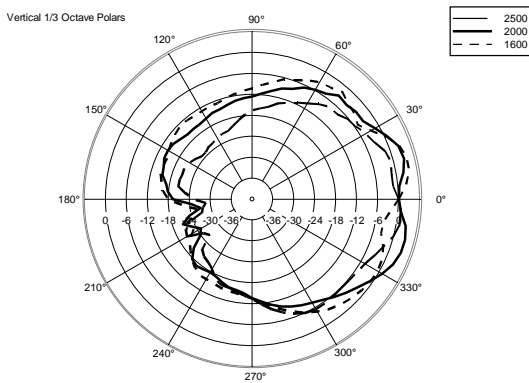
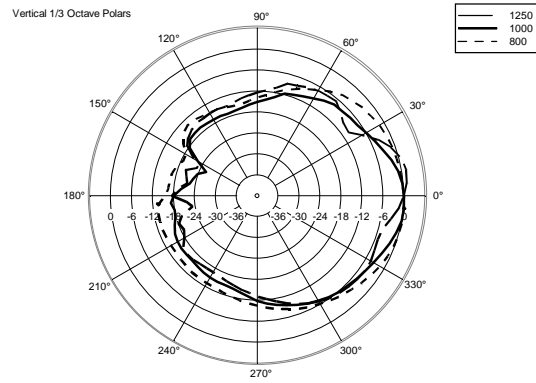
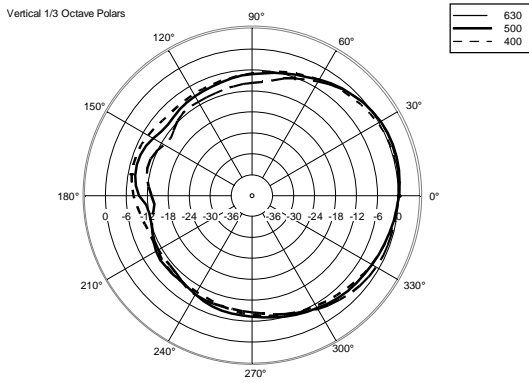
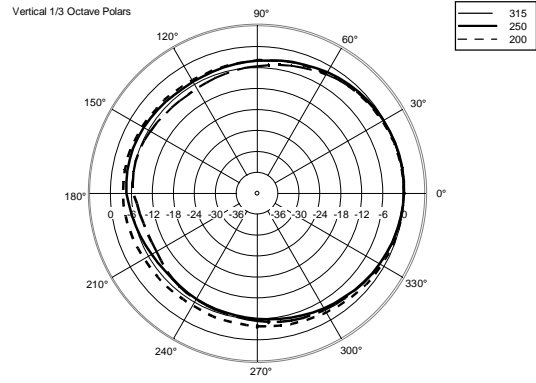
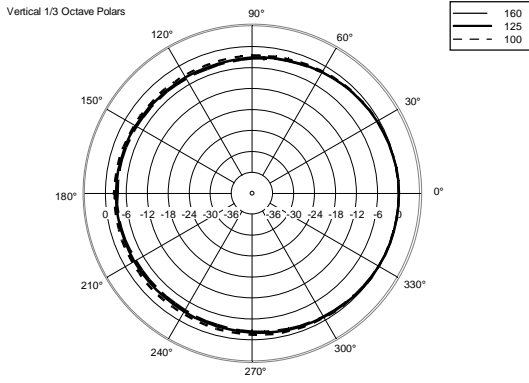

ACCESSORIES

AC WM-C WALL MOUNT FOR NEW COMPACT

PART NUMBER **13360199**
EAN: 8024530007355

HORIZ. BRACKET H-BR 2X COMPACT M 12

PART NUMBER **13360445**
EAN: 8024530018283

HORIZ. BRACKET H-BR 2X COMPACT M 12 W

PART NUMBER **13360464**
EAN: 8024530019570

PANEL PNL IN-OUT SPEAKON

PART NUMBER **12399062**
EAN: 8024530018733

VERTICAL BRACKET V-BR 2X COMPACT M 12

PART NUMBER **13360448**
EAN: 8024530018313

VERTICAL BRACKET V-BR 2X COMPACT M 12 W

PART NUMBER **13360467**
EAN: 8024530019556



A&E SPECIFICATIONS

The product shall be a multipurpose two-way full-range speaker, suitable for a wide range of applications, providing a balanced sound in near-field applications to get the best intelligibility.

It shall feature high sensitivity, typical of professional audio cabinets having oversized magnets and a Hi-Fi sound quality, with smooth and wide frequency response, thanks to a wave-guided compression driver.

Its design shall be elegant and compact with accurate finishing, suitable for almost any environment, even with architectural constraints.

Optional mounting accessories shall be available for wall or ceiling installations.
